2DRE

Aluminium gear flow dividers

Technical Catalogue

E0.120.0416.02.00IM03



GEAR DIVIDERS

A flow divider is composed by two or more modular elements (stages) with driving gears mechanically linked by an internal coupling sleeve, that causes them to turn at the same speed. Unlike multiple pumps, in which the input power is mechanical (shaft connected to a motor), in a flow divider the input power is hydraulic, i.e. a flow under pressure supplies the modular elements, which are connected to the hydraulic circuits serving the users.

The portion of flow elaborated by each element is determined by its nominal flow rate. Therefore, unlike standard static dividers with variable ports, the flow dividers do not cause dissipation and are much more precise. The use of flow dividers reduces the number of pumps necessary as well as the associated individual mechanical power takeoffs and complex mechanical couplers (with greater losses). The total input power is always equal to the sum of the powers supplied by all elements plus a small power loss, usually negligible.

Therefore, if in a period of time the power required by a hydraulic circuit is equal to zero (inactive drained circuit), the power supplied by the element feeding that circuit becomes available for the other elements, which may use it in their own circuits, also operating at higher pressures than the intake pressure.

Typical applications

Flow dividers

Supply of two or more independent hydraulic circuits by means of a single pump, with an overall flow rate equal to the sum of the flow rates.

Examples of this kind of application:

- lifting platforms and bridges;
- hydraulic bending presses and shearing machines;
- hoisting of freight containers;
- lubrication systems;
- hydraulic opening / closing of gates;
- automatic hydraulically-driven machines;
- actuation of formwork for construction;
- wood processing machinery;
- conveyance of trolleys driven by hydraulic cylinders or motors;
- equipment for the food industry;
- military installations.

Pressure amplifiers

If one line requires higher operating or peak pressure than the others, a flow divider becomes a better solution than a pressure upgrade of all the lines.

With a two-element flow divider the flow can be discharged from the outlet of the first element so that the pressure in the second element becomes higher than the pressure on the main pump.

Examples of this kind of application:

- presses with fast movements
- machine tools



TECHNICAL DATA

- Minimum operating fluid viscosity	12 mm ² / sec
- Max starting viscosity	800 mm ² / sec
- Suggested fluid viscosity range	17 - 65 mm ² / sec
- Fluid operating temperature range	-20 to 80 °C
- Fluid operating temperature range with FPM seals (Viton)	-15 to 110°C
- Fluid operating temperature range with HNBR seals*	-30 to 110°C
- Hydraulic fluid	mineral oil

*Available on request

FILTRATION INDEX RECOMMENDED

Working pressure	>200 bar/2900 psi	<200 bar/2900 psi
Contamination class NAS 1638	9	10
Contamination class ISO 4406	19/18/15	20/19/16
Achieved with filter $\beta_x=75$	15 μ m	25 μ m

For different TECHNICAL DATA, please get in touch with our technical department.

WORKING CONDITIONS

Max flow for each inlet section

When the inlet flow exceed the 40 l/min (1.5DRE)-80 l/min (2DRE), please get in touch with our technical department

When the flow divider is used as pressure intensifier, the pressure between sections can be higher.

P₁ Max continuous pressure

P₂ Max peak pressure

1.5DRE - Type	Displacement		Max outlet pressure				Max outlet Δ p		Speed		Flow per section		Flow per section	
			P ₁	P ₂	P ₁	P ₂	between sections		min.	max.	min.	max.	min.	max.
	cm ³ /rev	cu.in./rev	bar	bar	psi	psi	bar	psi	min-1		l/min		gpm	
1.5DRE - 2.8	2.8	0.17	250	270	3625	3915	50	725	1200	4500	3.54	13.26	0.93	3.49
1.5DRE - 3.5	3.5	0.21	250	270	3625	3915	50	725	1200	4500	4.42	16.58	1.16	4.36
1.5DRE - 4.1	4.1	0.25	250	270	3625	3915	50	725	1200	4000	5.18	17.26	1.36	4.54
1.5DRE - 5.2	5.2	0.32	230	250	3335	3625	50	725	1200	4000	6.57	21.89	1.73	5.76
1.5DRE - 6.2	6.2	0.38	230	250	3335	3625	50	725	1200	3400	7.83	22.19	2.06	5.84
1.5DRE - 7.6	7.6	0.46	200	220	2900	3190	50	725	1200	3400	9.60	27.20	2.53	7.16
1.5DRE - 9.3	9.3	0.57	180	200	2610	2900	50	725	1200	3000	11.75	29.37	3.09	7.73
1.5DRE - 11	11	0.67	170	190	2465	2755	50	725	1200	3000	13.89	34.74	3.66	9.14

E0.100.0416.02.00IM00



P₁ Max continuous pressure
P₂ Max peak pressure

2DRE - Type	Displacement		Max. Outlet Pressure				Max. Outlet Δp		Speed		Flow per section		Flow per section	
			p ₁	p ₂	p ₁	p ₂	between sections		min.	max.	min.	max.	min.	max.
	cm ³ /rev	cu.in./rev	bar	bar	psi	psi	bar	psi	min ⁻¹		l/min		gpm	
2DRE - 4,5	4.60	0.27	250	280	3600	4000	50	725	1250	3900	6.05	18.88	1.59	4.97
2DRE - 6,5	6.50	0.40	250	280	3600	4000	50	725	1250	3750	8.55	25.66	2.25	6.75
2DRE - 8,3	8.20	0.50	250	280	3600	4000	50	725	1200	3600	10.36	31.07	2.73	8.18
2DRE - 10,5	10.60	0.65	250	280	3600	4000	50	725	1200	3500	13.39	39.05	3.52	10.28
2DRE - 11,3	11.50	0.68	250	280	3600	4000	50	725	1200	3500	14.53	42.37	3.82	11.15
2DRE - 12,5	12.70	0.77	250	280	3600	4000	50	725	1200	3400	16.04	45.45	4.22	11.96
2DRE - 13,8	13.80	0.84	250	280	3600	4000	50	725	1200	3400	17.43	49.39	4.59	13.00
2DRE - 16	16.60	1.01	250	280	3600	4000	50	725	1100	3200	19.22	55.92	5.06	14.71
2DRE - 19	19.40	1.15	220	240	3150	3450	50	725	1100	3200	22.46	65.35	5.91	17.20
2DRE - 22,5	22.90	1.37	220	240	3150	3450	50	725	1100	3000	26.52	72.32	6.98	19.03
2DRE - 26	25.80	1.58	200	220	2900	3150	50	725	1100	2850	29.87	77.40	7.86	20.37
2DRE - 30	30.10	1.84	200	220	2900	3150	50	725	1100	2700	34.85	85.55	9.71	22.51

GUIDELINE FOR THE COMBINATION OF THE ELEMENTS

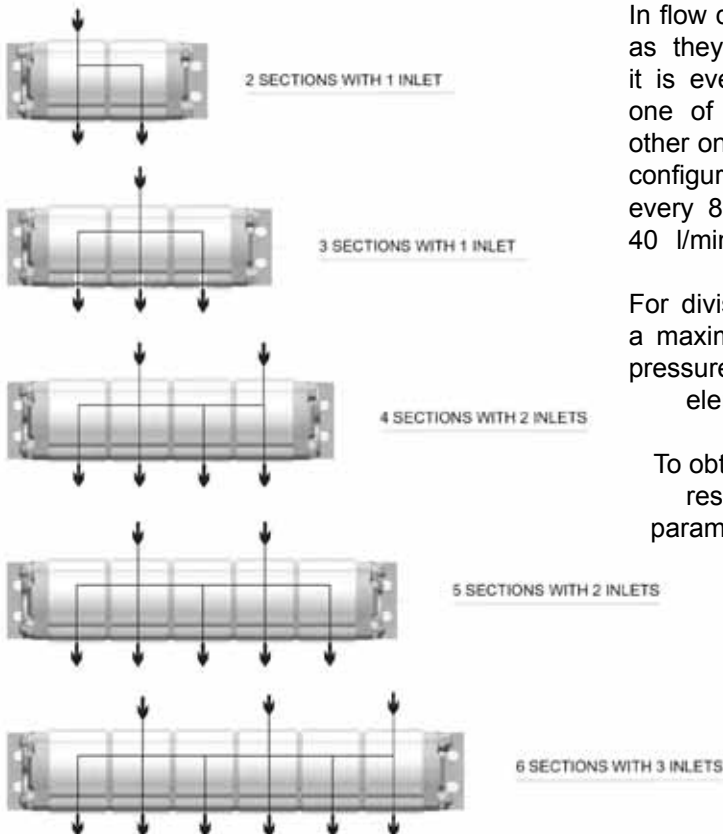

In flow dividers with many inlets, as they are all communicating it is even possible to use only one of them, by plugging the other ones. We suggest to make configurations with one inlet every 80 l/min (for 2DRE) and 40 l/min (for 1.5DRE) of flow elaborated.

For division error less than 4% a maximum level of differential pressure of 50 bar between elements is suggested.

To obtain high precisions the respect of the following parametres is also important:

Number of elements	Number of inlets
2	1
3	1
4	2
5	2
6	3
7	3
8	4

- Environment temperature	-1 0°c ÷ +60°c
- Hydraulic oil based on hlp, hv (din 51 524) minerals	
- Oil filtering	10 ÷ 25 μ
- Oil temperature	+30°c ÷ +60°c
- Oil Viscosity	20 ÷ 40 cSt

To fix the correct number and size of inlet working ports, please contact with our technical department.

EO.100.0416.02.001M00



DISPLACEMENT SELECTION

In order to equalize the flow, it needs to maintain the speed within the suggested speed range, with a Δp max of 50 bar (725 psi) between the different stages. Keeping these conditions, we can assure a flow deviation, within $\pm 2\%$ on the different stages.

- n = number of section
- $V_{1,2,\dots,n}$ = displacement sections [cm³/rev]
- $Q_{1,2,\dots,n}$ = flow sections [l/min]
- $P_{1,2,\dots,n}$ = pressure sections [bar]
- N = speed [rpm]
- $Q_0 = Q_1 + Q_2 + \dots + Q_n$ pump flow [l/min]
- $P_0 Q_0 = P_1 Q_1 + P_2 Q_2 + \dots + P_n Q_n$

$$V_i = \frac{1000 Q_i}{N}$$

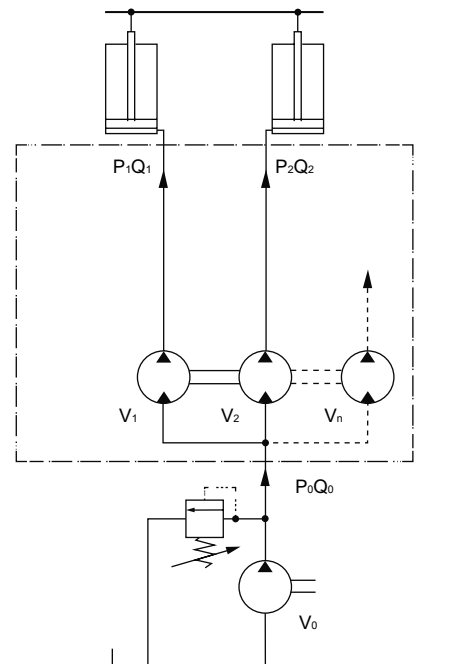

INDEX

Calculation Example.....	217
Flow Equalizer.....	217
Flow Divider.....	218
Assembling Dimensions	219
Valves.....	220
Assembling Dimensions-2DRE-AR.....	221
Assembling Dimensions-2DRE-VA.....	222
Ports.....	223
Flow Dividers.....	224
Flow Dividers-2DRE-AR.....	225
Flow Dividers-2DRE-VA.....	226

Final revised edition-April 2016

The data in this catalogue refers to the standard product.

The policy of Salami S.p.A. consists of a continuous improvement of its products. It reserves the right to change the specifications of the different products whenever necessary and without giving prior information.

If any doubts, please get in touch with our sales department.



CALCULATION EXAMPLE

Flow equalizer:

suppose we have to supply two cylinders, both with the same flow of 30l/min.

The flow equalizer's inlet flow Q_0 , delivered by the pump, will be 60l/min.

Follow the vertical line corresponding to the inlet flow of 60l/min up to cross the line which matches the 2 stages flow divider. Then we trace an horizontal line matching the flow of 30l/min for each stage on the Y axis up to the recommended speeds area where we intercept the line corresponding to the displacement of 10.5 cm³. We suggest you to choice the displacement with the highest rpm, within the recommended speeds area.

Flow divider:

suppose we have to supply two cylinders, the one with the flow of 30 l/min, the other with 50 l/min.

The flow equalizer inlet flow Q_0 , delivered by the pump, will be 60 l/min.

Starting from the Y axis, we trace 2 horizontal lines corresponding to the flows of 30 l/min and 25 l/min until we intercept the displacement lines with the highest value of rpm, within the recommended speeds area.

Pressure intensifier:

The working principle of rotary flow dividers do not dissipate energy, in fact if the pressure of outlet line of one stage is lower than the inlet pressure, this stage works as a motor and uses the the energy of the inlet flow.

This energy is not wasted but transferred, by the common shaft, to the other stage which operate as a pump therefore the outlet pressure will be higher than the inlet pressure.

FLOW EQUALIZER

All the data here showed were carried out with mineral oil at the temperature at 50°C with viscosity of 21 cSt

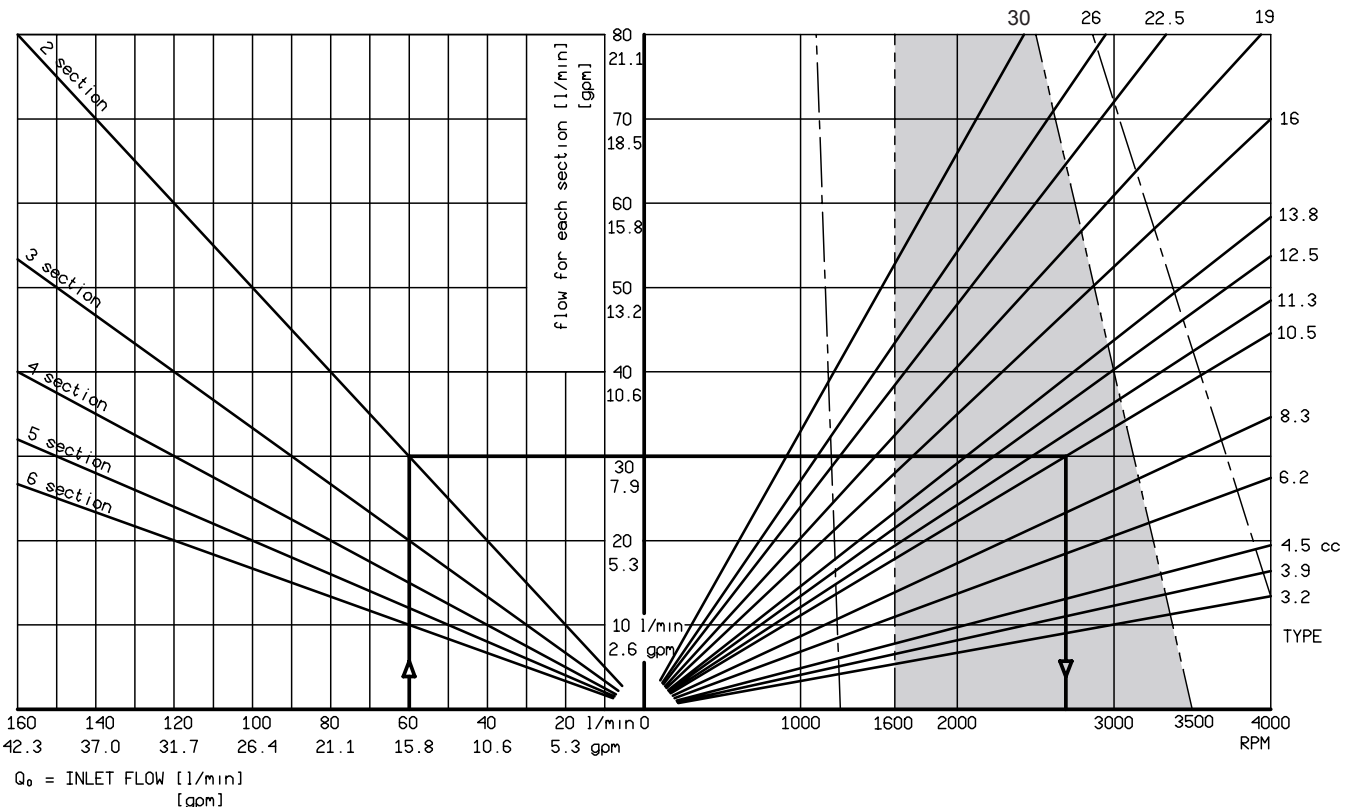

EO.120.0416.02.001M03



FLOW DIVIDER

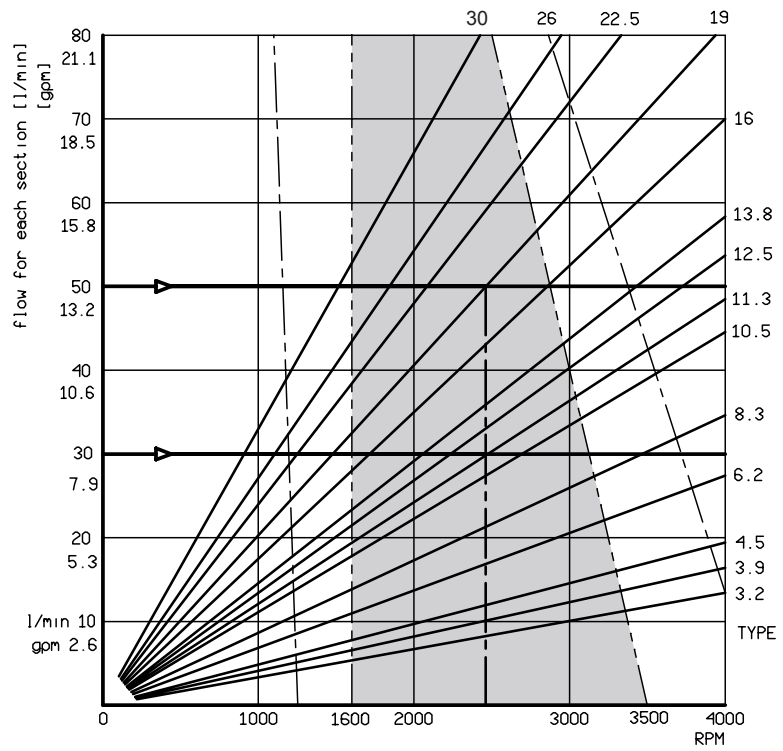
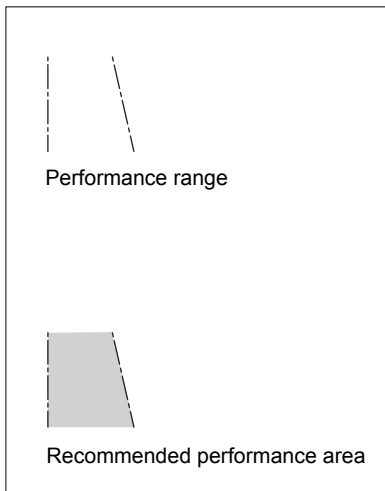

VALVES

Relief valves are used in order to realign the cylinders when they reach the end of the cycle. For example, when the cylinders extend, they may not reach the end of stroke at the same time, due to the differences of internal leakage between the stages. When the first one of a system of cylinders reaches its stroke end, the relief valve in this stage opens and by-pass the flow to tank, in this way it allows the other to reach their stop without causing damages in the system.

VA

Overload valve
(setting range from 50 to 275 bar - 725 to 4000 psi)

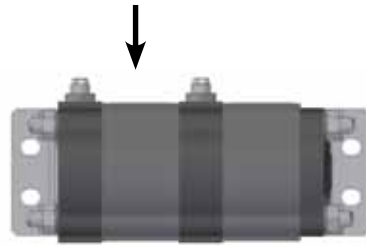
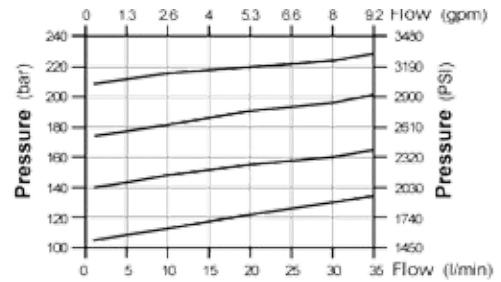
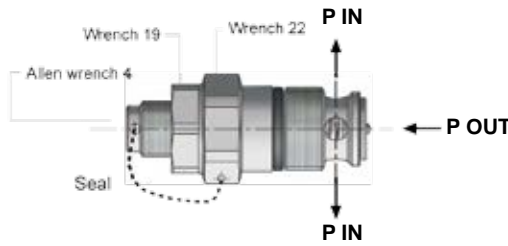
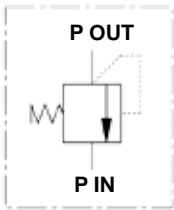

AR

Overload and anticavitation valve
(setting range from 50 to 275 bar - 725 to 4000 psi)

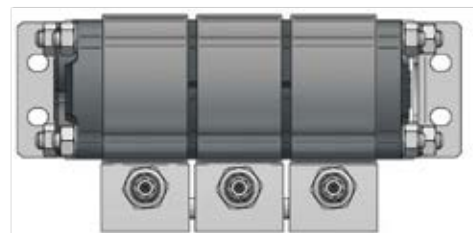
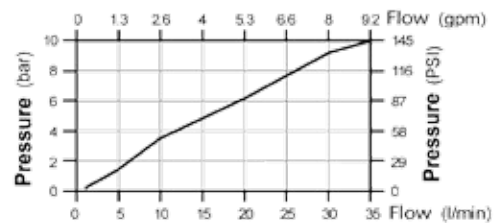
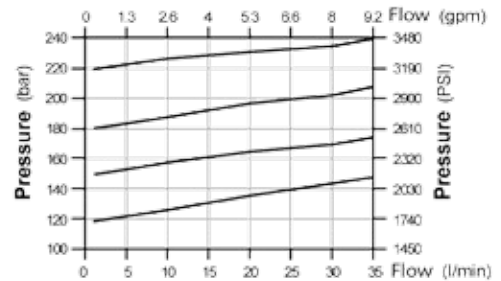
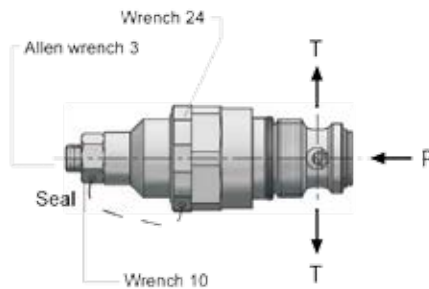
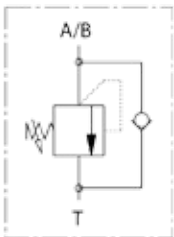

E0.120.0416.02.001M03



ASSEMBLING DIMENSIONS-2DRE-AR
(RELEASE WITH VALVES/EXTERNAL DISCHARGE)

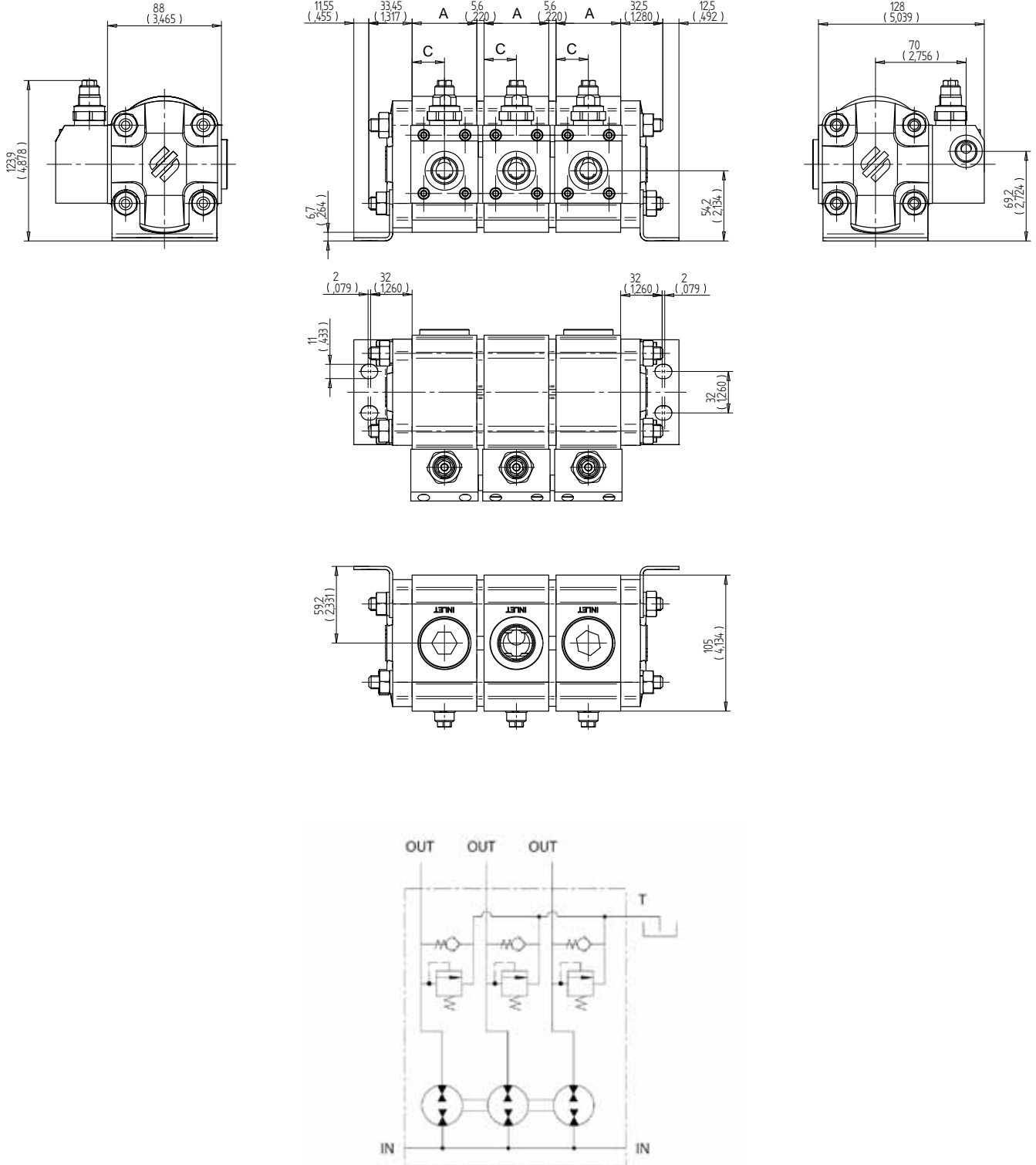

EO.120.0416.02.001M03



ASSEMBLING DIMENSIONS-2DRE-VA
(RELEASE WITH VALVES/INTERNAL BY PASS)

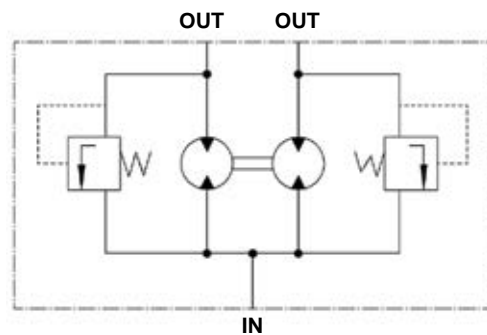
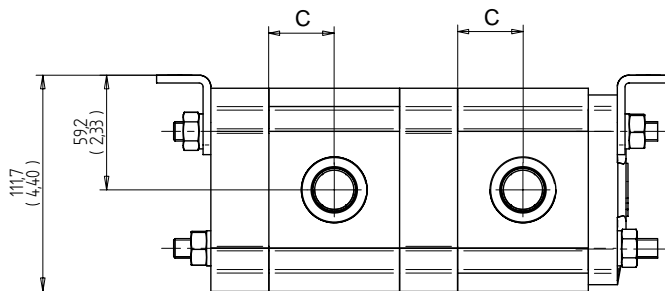
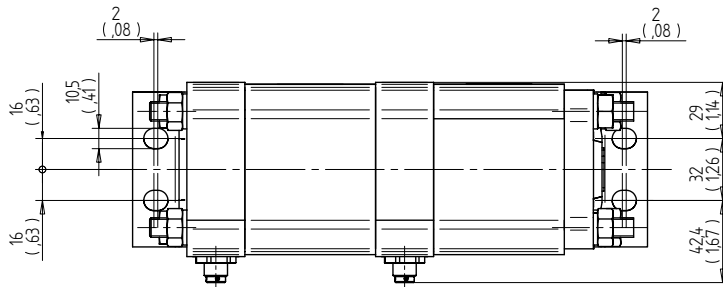
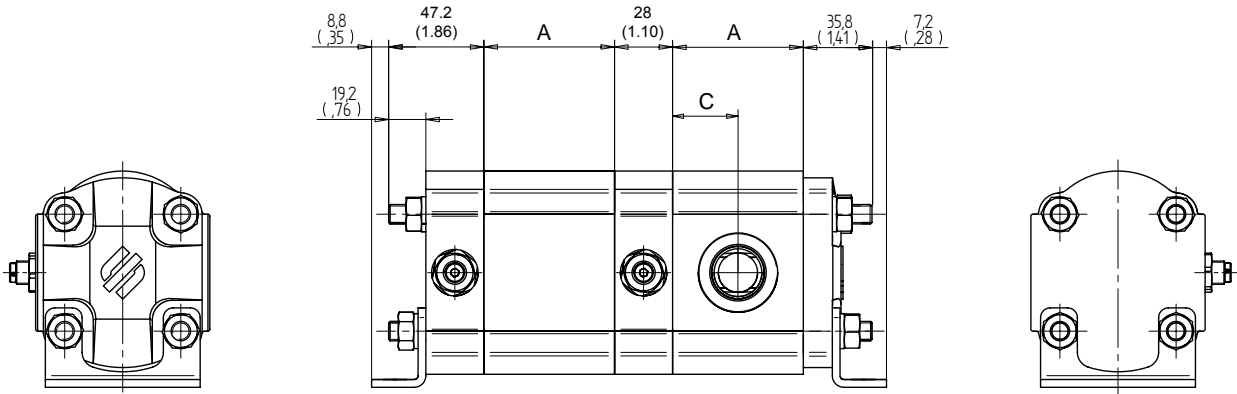

E0.120.0416.02.001M03



PORTS

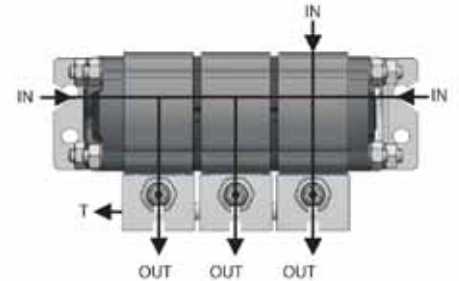
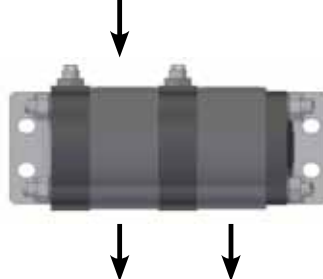
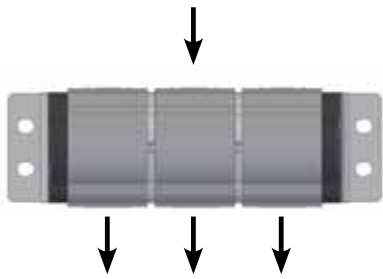

PORTS TYPE	BSPP			ODT		
	IN	OUT	T-T1	IN	OUT	T-T1
2DRE - 4,5	G3/4	G1/2	G3/8	1-1/16-12 UN (SAE 12)	7/8-14 UNF (SAE 10)	9/16-18 UNF (SAE 6)
2DRE - 6,5						
2DRE - 8,3						
2DRE - 10,5						
2DRE - 11,3						
2DRE - 12,5						
2DRE - 13,8						
2DRE - 16						
2DRE - 19						
2DRE - 22,5						
2DRE - 26						
2DRE - 30						

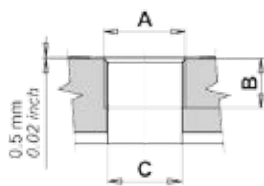

code G

Threaded ports
GAS (BSPP)

INLET			OUTLET		
A	B	C	A	B	C
G3/4	16 (0.62")	20 (0.78")	G1/2	15 (0.58")	

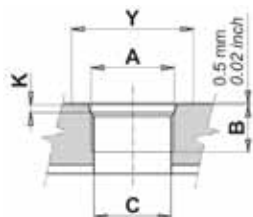

code R

Threaded ports
SAE (ODT)

INLET					OUTLET				
A	B	C	Y	K	A	B	C	Y	K
1-1/16-12 UN (SAE 12)	19 (0.74")	20 (0.78")	41 (1.16")	3.3 (0.12")	7/8-14 UNF (SAE 10)	14 (0.54")	15 (0.58")	34 (1.34")	2.5 (0.10")

EO.120.0416.02.001M03



FLOW DIVIDERS

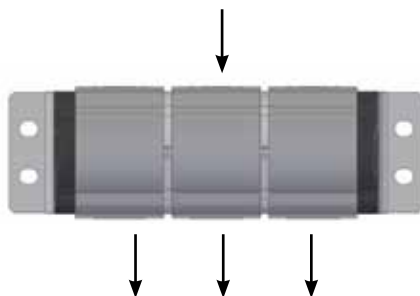

2DRE / **A** - **B** / **C** **E** / (**C** **E** **E** / **C** **E** / **B**) - **D**

G / 0 / 4.1 O / 4.1 I O / 4.1 O / 1 - V

PORTS (page 223)	CODES	A
GAS threaded ports (BSPP)	G	
SAE threaded ports (ODT)	R	

SIDE COVERS	CODES	B
Without inlet port	0	
With inlet port	1	

TYPE	DISPLACEMENTS		C
4.5	4.60 cm ³ /rev.	0.27 cu.in/rev.	
6.5	6.50 cm ³ /rev.	0.40 cu.in/rev.	
8.3	8.20 cm ³ /rev.	0.50 cu.in/rev.	
10.5	10.60 cm ³ /rev.	0.65 cu.in/rev.	
11.3	11.50 cm ³ /rev.	0.68 cu.in/rev.	
12.5	12.70 cm ³ /rev.	0.77 cu.in/rev.	
13.8	13.80 cm ³ /rev.	0.84 cu.in/rev.	
16	16.60 cm ³ /rev.	1.01 cu.in/rev.	
19	19.40 cm ³ /rev.	1.15 cu.in/rev.	
22.5	22.90 cm ³ /rev.	1.37 cu.in/rev.	
26	25.80 cm ³ /rev.	1.58 cu.in/rev.	
30	30.10 cm ³ /rev.	1.84 cu.in/rev.	

BODIES	CODES	E
Body with outlet port only	O	
Body with inlet and outlet ports	IO	

SEAL	CODE	D
Buna standard		
Viton	V	

Proceeding as per our example above, when you have to set up a 2DRE flow divider, beginning from the right side you have to specify:

- Side cover (with or without inlet port)
- Stages → **displacement**
→ **bodies** outlet port only or both inlet and outlet ports
- Side cover (with or without inlet ports)
- Not specified if you want our standard Buna nitrile seals, you have to put V if you want the Viton seals.



FLOW DIVIDERS-2DRE-AR

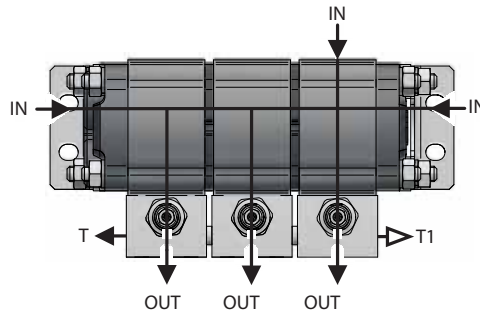

Setting valve(bar)

2DRE-AR / **A** - **B** **C** / ... / **D** **F** **F** / **G** (C) / **D** **F** / **B**) - **E**

/ **G** - **2** **AR** ... / **2.1** **I** **O** / **3** **AR** **140** / **2.1** **O** / **1** - **V**

PORTS (page 223)	CODES	A
GAS threaded ports (BSPP)	G	
SAE threaded ports (ODT)	R	

SIDE COVERS	CODES	B
Without inlet port	0	
With inlet port	1	
Pre-arranged for valve VA	2	

VALVE	CODES	C
Overload and anti-cavitation valve	AR	

TYPE	DISPLACEMENTS		D
4.5	4.60 cm ³ /rev.	0.27 cu.in/rev.	
6.5	6.50 cm ³ /rev.	0.40 cu.in/rev.	
8.3	8.20 cm ³ /rev.	0.50 cu.in/rev.	
10.5	10.60 cm ³ /rev.	0.65 cu.in/rev.	
11.3	11.50 cm ³ /rev.	0.68 cu.in/rev.	
12.5	12.70 cm ³ /rev.	0.77 cu.in/rev.	
13.8	13.80 cm ³ /rev.	0.84 cu.in/rev.	
16	16.60 cm ³ /rev.	1.01 cu.in/rev.	
19	19.40 cm ³ /rev.	1.15 cu.in/rev.	
22.5	22.90 cm ³ /rev.	1.37 cu.in/rev.	
26	25.80 cm ³ /rev.	1.58 cu.in/rev.	
30	30.10 cm ³ /rev.	1.84 cu.in/rev.	

G	MID PLATE	CODE
	Pre-arranged for valve VA	3

F	BODIES	CODES
	Body with outlet port only	O
	Body with inlet and outlet ports	IO

E	SEAL	CODE
	Buna standard	
	Viton	V

EO.120.0416.02.00IM03



FLOW DIVIDERS-2DRE-VA

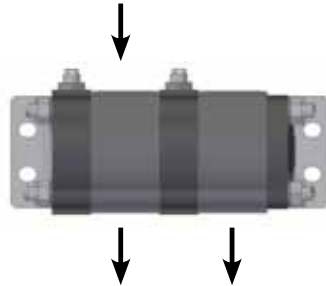

PORTS (page 223)	CODES	A
GAS threaded ports (BSPP)	G	
SAE threaded ports (ODT)	R	

SIDE COVERS	CODES	B
Without inlet port	0	
With inlet port	1	
Pre-arranged for valve VA	2	

VALVE	CODES	C
Adjustable overload valve	VA	

TYPE	DISPLACEMENTS		D
4.5	4.60 cm ³ /rev.	0.27 cu.in/rev.	
6.5	6.50 cm ³ /rev.	0.40 cu.in/rev.	
8.3	8.20 cm ³ /rev.	0.50 cu.in/rev.	
10.5	10.60 cm ³ /rev.	0.65 cu.in/rev.	
11.3	11.50 cm ³ /rev.	0.68 cu.in/rev.	
12.5	12.70 cm ³ /rev.	0.77 cu.in/rev.	
13.8	13.80 cm ³ /rev.	0.84 cu.in/rev.	
16	16.60 cm ³ /rev.	1.01 cu.in/rev.	
19	19.40 cm ³ /rev.	1.15 cu.in/rev.	
22.5	22.90 cm ³ /rev.	1.37 cu.in/rev.	
26	25.80 cm ³ /rev.	1.58 cu.in/rev.	
30	30.10 cm ³ /rev.	1.84 cu.in/rev.	

G	MID PLATE	CODE
3	Pre-arranged for valve VA	3

F	BODIES	CODES
	Body with outlet port only	O
	Body with inlet and outlet ports	IO

E	SEAL	CODE
	Buna standard	
	Viton	V

E0.120.0416.02.001M03



You can find our most up to date “STANDARD SALES CONDITIONS” on our website.

Potete trovare le nostre più aggiornate “CONDIZIONI DI VENDITA STANDARD” sul nostro sito.

www.salami.it

T. +39 059 387 411

sales@salami.it

Watch our tutorials on youtube channel



Salami Fluid Power
Salami Fluid Power World
Salami Fluid Power France
Salami Fluid Power España
Salami Fluid Power Deutsch

SALAMI S.P.A.

Via Emilia Ovest 1006
41121 Modena (Italy)
T. +39 059 387 411
F. +39 059 387 639
sales@salami.it

SALAMI ESPAÑA

Poligono Industrial Armenteres
C/Primer de Maig, 18, Nave 4
08980 San Feliu de Llobregat
Barcelona
T. +34-93-6327288
F. +34-93-6667826
info@salamispain.com

SALAMI FRANCE

22, rue Louis Saillant
69120 Valux en Velin
Lyon
T. +33-04-78809941
F. +33-04-78804264
e.pasian@salami.fr

SALAMI HYDRAULICS N.A INC

Loop Road
Baldwinsville
NY 13027 - USA
T. +1-315-295-2363
F. +1-315-295-2364
info@salamihydraulics.com